

DC Axial-Flow Fan



70×70×10mm

★ General Specification(一般规格)

- ☆ Material: Frame And Impeller: Thermal Plastic UL 94V-0
- ☆ Lead Wires: UL Type
 - RED Wire Positive(+)
 - BLACK Wire Negative(-)
- ☆ Insulation Resistance: 10MΩ Or Over With a DC250V Megger
- ☆ Dielectric Withstand Voltage: AC500V 1S
- ☆ Allowable Ambient Temperature Range:
 - 10°C ~ +70°C(Operation)
 - 40°C ~ +70°C(Storage)

★ Dimensions Drawing(外观图)

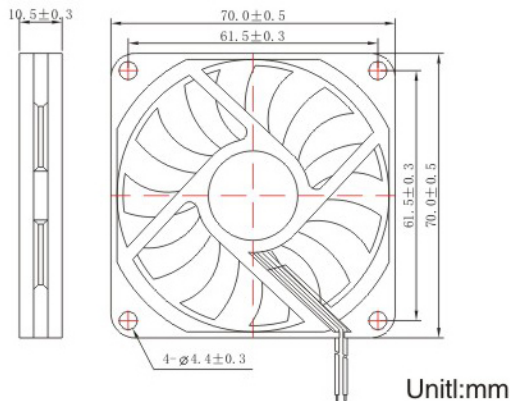

★ Characteristic Curves(特性曲线)

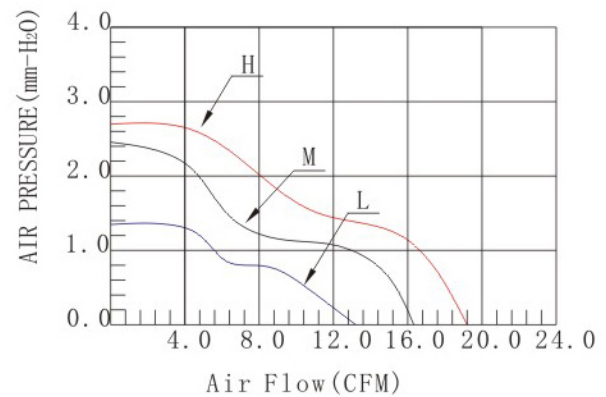

★ Specifications(规格)

Model (型号)	Bearing System (培林)	Rated Voltage (V) (电压)	Operation Voltage (V) (电压范围)	Current (A) (电流)	Input power (W) (功率)	Speed (RPM) (转速)	Air Flow (CFM) (风量)	Static Pressure (mm-H ₂ O) (静压)	Noise Level (dB-A) (噪音)	Weight (g) (重量)
YD127010HS	Sleeve	5	10.8~13.2	0.21	2.52	3500	19.13	2.65	32.60	33
YD127010MS				0.14	1.68	3000	16.39	2.48	27.95	33
YD127010LS				0.10	1.20	2500	13.31	1.28	23.86	33
YD127010HB	Ball			0.21	2.52	3500	19.13	2.65	32.60	33
YD127010MB				0.14	1.68	3000	16.39	2.48	27.95	33
YD127010LB				0.10	1.20	2500	13.31	1.28	23.86	33
YD247010HS	Sleeve	12	21.6~26.4	0.13	3.12	3500	19.13	2.65	32.60	33
YD247010MS				0.11	2.64	3000	16.39	2.48	27.95	33
YD247010LS				0.08	1.92	2500	13.31	1.28	23.86	33
YD247010HB	Ball			0.13	3.12	3500	19.13	2.65	32.60	33
YD247010MB				0.11	2.64	3000	16.39	2.48	27.95	33
YD247010LB				0.08	1.92	2500	13.31	1.28	23.86	33