



30×30×6 mm

DC Axial-Flow Fan

★ General Specification(一般规格)

☆ Material: Frame And Impeller: Thermal Plastic UL 94V-0

☆ Lead Wires: UL Type

RED Wire Positive(+)

BLACK Wire Negative(-)

☆ Insulation Resistance: 10MΩ Or Over With a DC250V Megger

☆ Dielectric Withstand Voltage: AC500V 1S

☆ Allowable Ambient Temperature Range:

-10°C ~ +70°C(Operation)

-40°C ~ +70°C(Storage)

★ Dimensions Drawing(外观图)

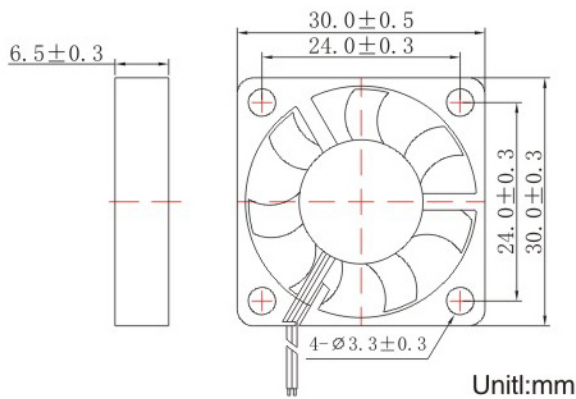

★ Characteristic Curves(特性曲线)

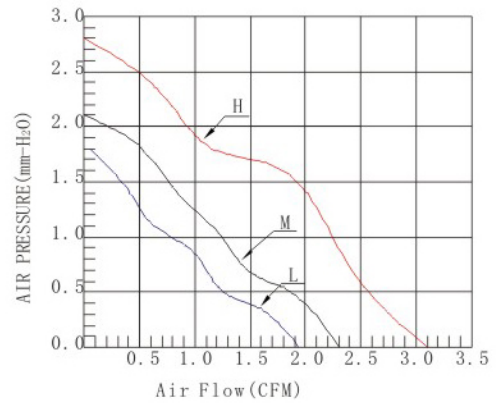

★ Specifications(规格)

Model (型号)	Bearing System (培林)	Rated Voltage (V) (电压)	Operation Voltage (V) (电压范围)	Current (A) (电流)	Input power (W) (功率)	Speed (RPM) (转速)	Air Flow (CFM) (风量)	Static Pressure (mm-H ₂ O) (静压)	Noise Level (dB-A) (噪音)	Weight (g) (重量)
YD053006HS	Sleeve	5	4.5~5.5	0.20	1.0	8000	3.09	2.87	25.44	7
YD053006MS				0.16	0.8	6000	2.32	2.15	21.25	7
YD053006LS				0.12	0.6	5000	1.93	1.79	20.11	7
YD053006HB	Ball			0.20	1.0	8000	3.09	2.87	25.44	7
YD053006MB				0.16	0.8	6000	2.32	2.15	21.25	7
YD053006LB				0.12	0.6	5000	1.93	1.79	20.11	7
YD123006HS	Sleeve	12	10.8~13.2	0.12	1.44	8000	3.09	2.87	25.44	7
YD123006MS				0.10	1.2	6000	2.32	2.15	21.25	7
YD123006LS				0.08	0.96	5000	1.93	1.79	20.11	7
YD123006HB	Ball			0.12	1.44	8000	3.09	2.87	25.44	7
YD123006MB				0.10	1.2	6000	2.32	2.15	21.25	7
YD123006LB				0.08	0.96	5000	1.93	1.79	20.11	7