



80×80×10mm

DC Axial-Flow Fan

★ General Specification(一般规格)

☆ Material: Frame And Impeller: Thermal Plastic UL 94V-0

☆ Lead Wires: UL Type

RED Wire Positive(+)

BLACK Wire Negative(-)

☆ Insulation Resistance: 10MΩ Or Over With a DC250V Megger

☆ Dielectric Withstand Voltage: AC500V 1S

☆ Allowable Ambient Temperature Range:

-10°C ~ +70°C(Operation)

-40°C ~ +70°C(Storage)

★ Dimensions Drawing(外观图)

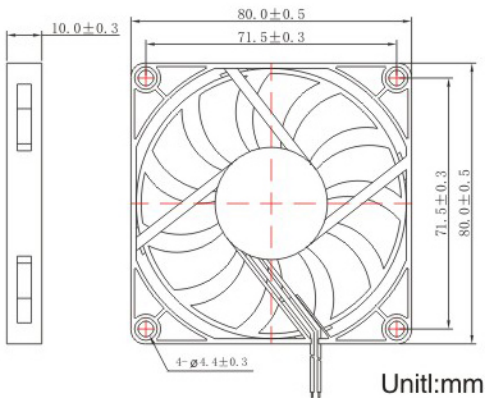

★ Characteristic Curves(特性曲线)

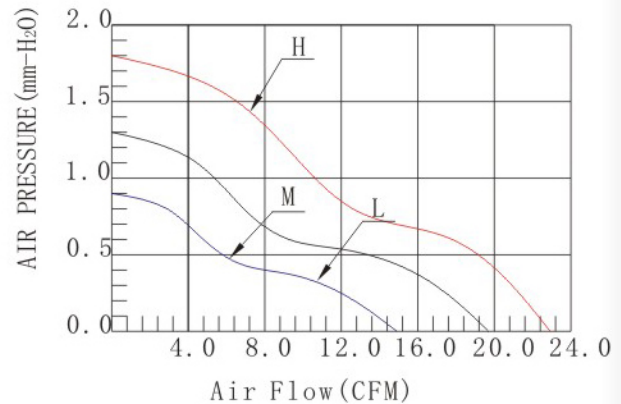

★ Specifications(规格)

Model (型号)	Bearing System (培林)	Rated Voltage (V) (电压)	Operation Voltage (V) (电压范围)	Current (A) (电流)	Input power (W) (功率)	Speed (RPM) (转速)	Air Flow (CFM) (风量)	Static Pressure (mm-H ₂ O) (静压)	Noise Level (dB-A) (噪音)	Weight (g) (重量)
YD058010HS	Sleeve	5	10.8~13.2	0.35	1.75	3000	23.45	1.81	30.75	43
YD058010MS				0.25	1.25	2500	19.68	1.31	26.25	43
YD058010LS				0.17	0.85	2000	15.58	0.09	22.08	43
YD058010HB	Ball			0.35	1.75	3000	23.45	1.81	30.75	43
YD058010MB				0.25	1.25	2500	19.68	1.31	26.25	43
YD058010LB				0.17	0.85	2000	15.58	0.09	22.08	43
YD128010HS	Sleeve	12	21.6~26.4	0.24	2.88	3000	23.45	1.81	30.75	43
YD128010MS				0.18	2.16	2500	19.68	1.31	26.25	43
YD128010LS				0.12	1.44	2000	15.58	0.09	22.08	43
YD128010HB	Ball			0.24	2.88	3000	23.45	1.81	30.75	43
YD128010MB				0.18	2.16	2500	19.68	1.31	26.25	43
YD128010LB				0.12	1.44	2000	15.58	0.09	22.08	43