



50×50×15mm

DC Axial-Flow Fan

★ General Specification(一般规格)

- ☆ Material: Frame And Impeller: Thermal Plastic UL 94V-0
- ☆ Lead Wires: UL Type
 - RED Wire Positive(+)
 - BLACK Wire Negative(-)
- ☆ Insulation Resistance: 10MΩ Or Over With a DC250V Megger
- ☆ Dielectric Withstand Voltage: AC500V 1S
- ☆ Allowable Ambient Temperature Range:
 - 10°C ~ +70°C(Operation)
 - 40°C ~ +70°C(Storage)

★ Dimensions Drawing(外观图)

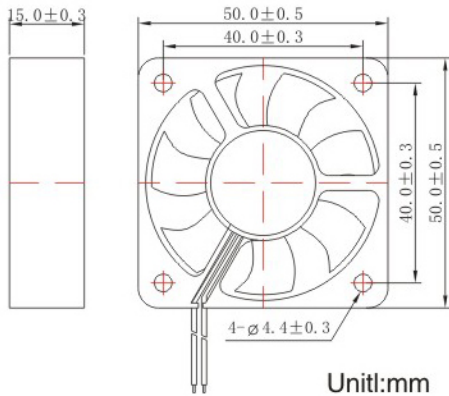

★ Characteristic Curves(特性曲线)

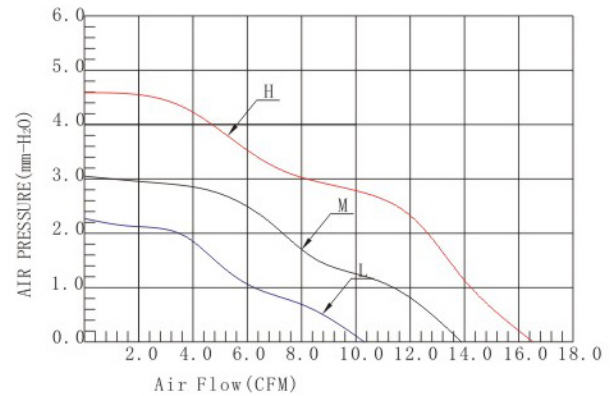

★ Specifications(规格)

Model (型号)	Bearing System (培林)	Rated Voltage (V) (电压)	Operation Voltage (V) (电压范围)	Current (A) (电流)	Input power (W) (功率)	Speed (RPM) (转速)	Air Flow (CFM) (风量)	Static Pressure (mm-H ₂ O) (静压)	Noise Level (dB-A) (噪音)	Weight (g) (重量)
YD055015HS	Sleeve	5	4.5~5.5	0.30	1.50	5500	16.50	4.58	36.42	29
YD055015MS				0.23	1.15	4500	13.94	3.04	31.74	29
YD055015LS				0.17	0.85	3500	10.85	2.25	29.39	29
YD055015HB	Ball			0.30	1.50	5500	16.50	4.58	36.42	29
YD055015MB				0.23	1.15	4500	13.94	3.04	31.74	29
YD055015LB				0.17	0.85	3500	10.85	2.25	29.39	29
YD125015HS	Sleeve	12	10.8~13.2	0.16	1.92	5500	16.50	4.58	36.42	29
YD125015MS				0.12	1.44	4500	13.94	3.04	31.74	29
YD125015LS				0.08	0.96	3500	10.85	2.25	29.39	29
YD125015HB	Ball			0.16	1.92	5500	16.50	4.58	36.42	29
YD125015MB				0.12	1.44	4500	13.94	3.04	31.74	29
YD125015LB				0.08	0.96	3500	10.85	2.25	29.39	29